

TABLE OF CONTENTS

Chapter 1: GETTING STARTED	1
Chapter 2: MANUFACTURER'S RECOMMENDED MAINTENANCE	5
Chapter 3: DIAGNOSIS AND TROUBLESHOOTING	8
Chapter 4: SERVICING YOUR MACHINE	11
Chapter 5: SPARE PARTS LIST AND LOANER PARTS LIST	32

CHAPTER 1: GETTING STARTED

START UP PACKAGE (Included):

- One gallon of Storm Super Concentrate Cleaner (1 oz. per tank of water)
- One gallon of Storm Super Shine Polish
- Polishing Pads (3) – 100 polishes per pad
- Abralon™ Pads (12 of each) – 500, 1000, and 2000 grit – 25 sands per pad

MACHINE SET UP

1. Open the top and front panels.
2. Remove moisture absorption packets (2) – one in top compartment and one in front compartment – and discard.
3. Inside the front compartment you will find the water/cleaner reservoir. Close the valves (2) on the hose that comes out of the reservoir by rotating the two wing nuts on each side of the coupler 90 degrees. This will allow you to proceed without spilling liquid from the reservoir.
4. Disconnect the coupler by pulling back the ring and pulling both ends of the coupler to separate.
5. Remove drain pipe from the top of the reservoir and leave hanging.
6. Remove reservoir from compartment. There will be several components inside the reservoir that must be removed. They are:
 - a. A black filter for the reservoir
 - b. A supply of polishing pads
 - c. Additional maintenance items
7. Take black filter and install by stretching opening around the top edge of the reservoir. This will keep all of the debris away from the opening where the hose is attached to the reservoir and will allow clean water to be used in the polishing and resurfacing process.
8. Add one (1) ounce of Storm Surface Factory Cleaner to the reservoir. *It is important to use only one ounce. Any more may cause foaming and damage to your machine.*
9. Fill reservoir approximately 2/3 full with clean water.

NOTE:

Never allow the water in the reservoir to go below where the hose comes out of the reservoir. This will cause the water pump to burn out.

10. Re-secure the lid on the top of the reservoir and put in the bottom compartment the same way it was removed.
11. Re-insert the drain hose into the opening on the lid of the reservoir.

12. Attach the coupling by pulling back the ring, placing the two ends together and then releasing the ring.
13. Open both valves on each side of the coupling by rotating the wing nuts counter-clockwise 90 degrees. This will allow the water to flow freely to the machine. (VERY IMPORTANT)
14. Attached to the front door is the polish reservoir. Fill this compartment with Storm Super Shine Polish at least 2/3 full.
15. Top Panel components:
 - a. **The Primer Switch** – this switch will allow you to pull polish from the polish reservoir up to the nozzle inside the top cover so that the machine is ready when you turn it on. Once you do this you should not have to do it again unless your machine runs completely out of polish.
 - b. **The Polish/Sand Switch** – This switch will allow you to choose which mode you are in. If you choose the sand side of the switch only water will be allowed into the ball compartment. If you are on the polish side then polish *and* water will be allowed in. If the machine is in the neutral position, the machine will not dispense anything into the ball compartment.
 - c. **The Dial** – At this point your machine should be ready to use. Take a ball that you would like to resurface and decide what finish you would like the ball to be (500, 1000, 2000.)
 - (1) If you choose to resurface a ball to 2000 start with the 500 abralon pad and work your way up. Take the pad and install red part down on the Velcro padded disk.
 - (2) Place the ball in the compartment and select the sand mode on the switch. Turn the dial to the right slowly until your machine starts to sand the ball. This cycle will last for four minutes. If you would like to sand it for less you can turn the dial clockwise to the appropriate time, halfway being two minutes.
 - (3) After this cycle is done remove the ball and remove the 500 Abralon pad and insert the 1000 Abralon pad. Repeat the process. When this is complete do the same process with a 2000 Abralon pad.
 - (4) After the sanding process is complete it is time to polish the ball. Remove the ball and wipe off excess moisture. Remove the Abralon pad and install the manila colored polishing pad. Place the ball in the compartment and shut the lid. Place the switch on the polish mode and select the amount of time you would like to polish the ball for. Two minutes is a medium polish.
 - (a) It is recommended to polish the ball one minute at a time until you are familiar with the machines polishing capabilities.
 - (5) When polish cycle is complete remove ball and wipe off excess polish and your ball is ready to use.

CHAPTER 2: MANUFACTURER'S RECOMMENDED MAINTENANCE**➤ WEEKLY**

- Change water and cleaner (may need to be done more often depending on usage).
- Check all Abralon pads and polish pads. Ensure supply is sufficient.
- Check polish level of machine and refill as needed.

➤ QUARTERLY

- Check rubber retainer pad for wear and replace if necessary.
- Check belts for fraying and replace if necessary.
- Check hoses for leaking or signs of wear and replace if necessary.

➤ ANNUALLY

- Change rubber retainer pad.

**Maintenance intervals may vary based on amount of use.*

CHAPTER 3: DIAGNOSIS AND TROUBLESHOOTING

ISSUE	POSSIBLE CAUSE / SOLUTION
<p style="text-align: center;">POLISH ISN'T COMING OUT</p>	<ol style="list-style-type: none"> 1. Check polish level in reservoir. 2. Check that polishing pump is working by holding primer switch down, listening for pump and watching for polish to come through hose. 3. Loosen pump to check the pump hose. Replace hose if black rubber hose is damaged. 4. Replace urethane hose for supplying polish. 5. Replace pump if it is not operating.
<p style="text-align: center;">WATER AND CLEANER ARE NOT COMING OUT</p>	<ol style="list-style-type: none"> 1. Check water level in reservoir. 2. After switching mode to sanding, check if pump is operating normally by operating machine. <ol style="list-style-type: none"> a. Check to make sure both wingnuts from reservoir are in open position. <i>(Both should be parallel to hose they are connected to.)</i> b. If pump is operating but no water is coming out, disassemble head section of water pump to see if entrance or exit is blocked. c. Check to see whether water supply is blocked from reservoir.
<p style="text-align: center;">SANDING/ POLISHING DISK ISN'T ROTATING</p>	<ol style="list-style-type: none"> 1. Check belt to see if loose or broken. 2. Check motor – if not working replace motor.
<p style="text-align: center;">MACHINE WILL NOT POWER UP</p>	<ol style="list-style-type: none"> 1. Check fuse. 2. Check power cord at machine and wall. 3. Check power switch.
<p style="text-align: center;">MACHINE POWERS UP, BUT WON'T RUN</p>	<ol style="list-style-type: none"> 1. Check cover switch to make sure it moves into closed position. 2. Replace relay.

CHAPTER 4: SERVICING YOUR MACHINE

► Replacement of Sanding/Polishing Drive Motor and Belt

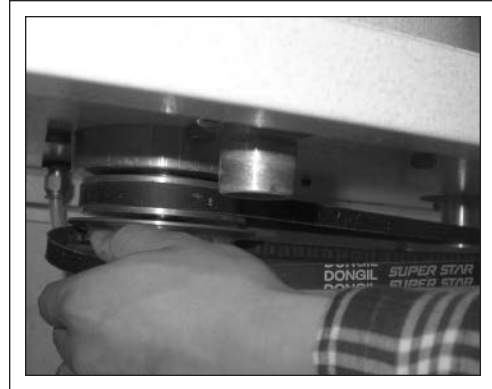
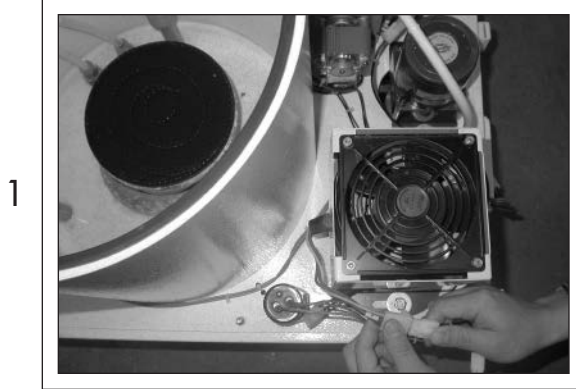

► Replacement of Brightener Pump and Pump Hose

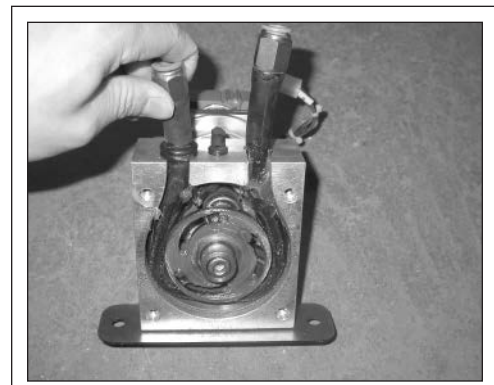
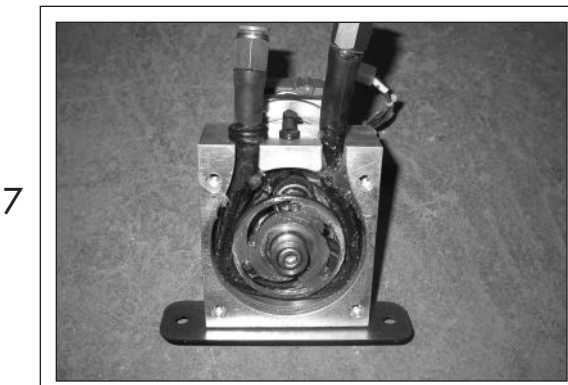
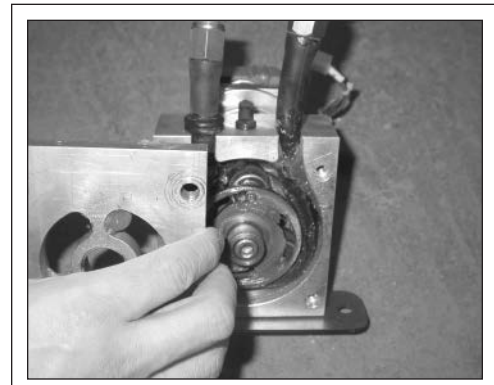
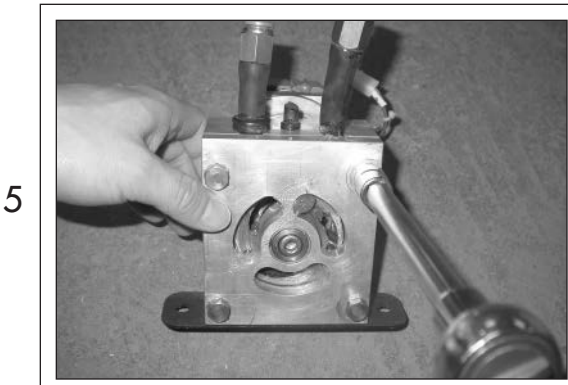
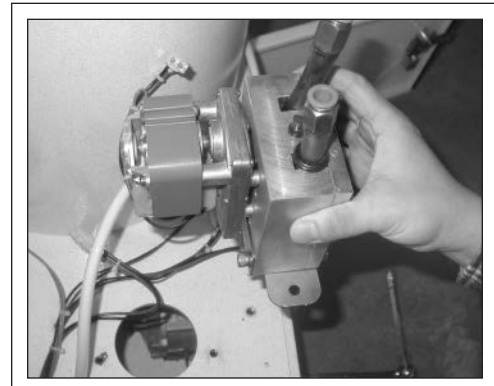
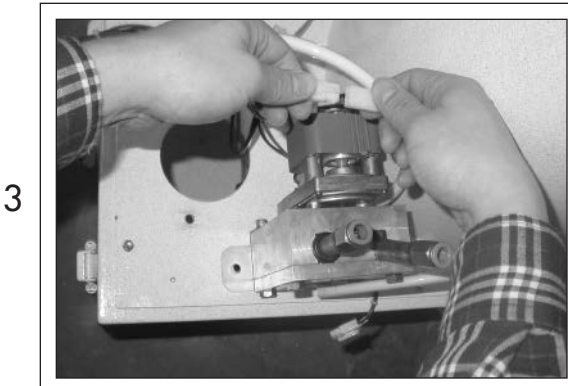
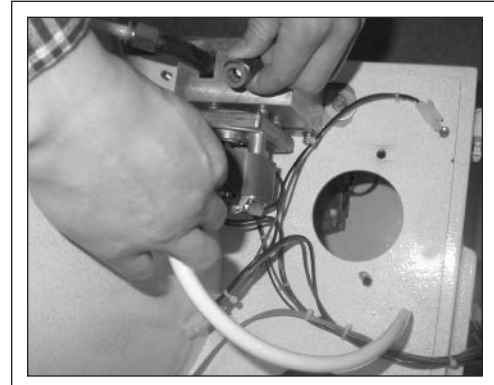
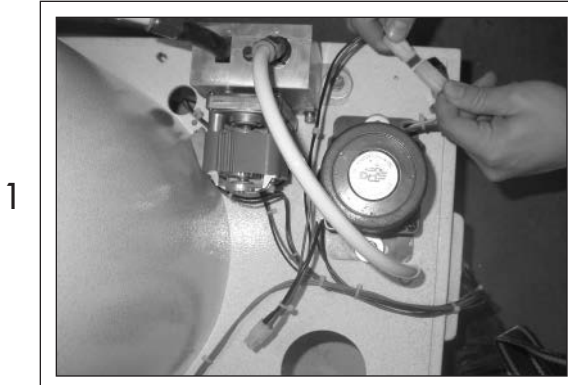

► Replacement of Brightener Pump and Pump Hose (*continued*)

9



10

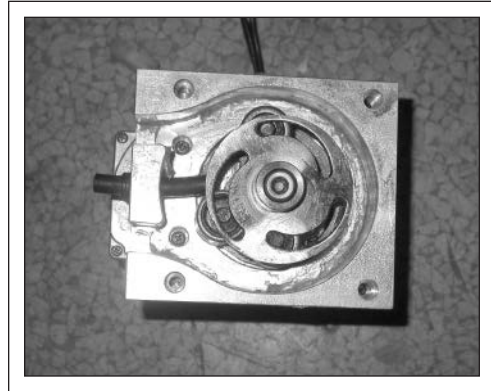

► Replacement of Water Pump

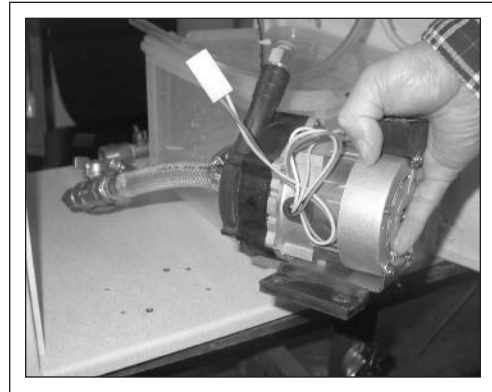
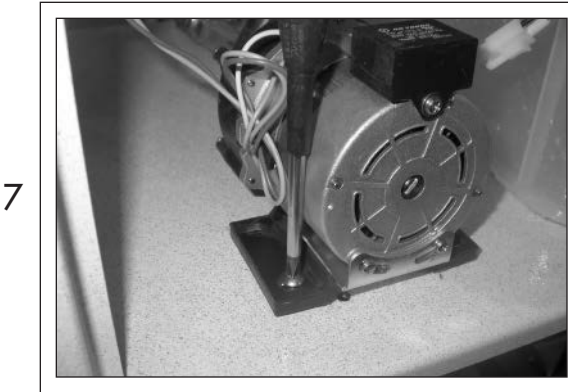
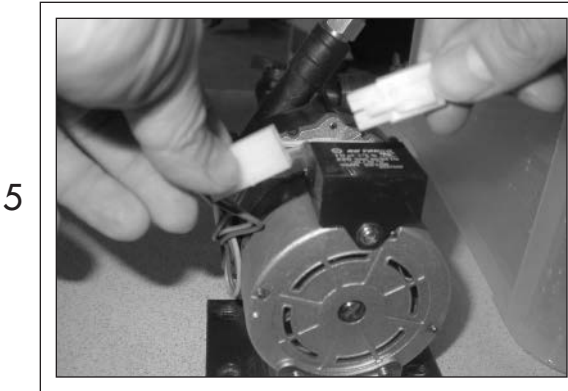
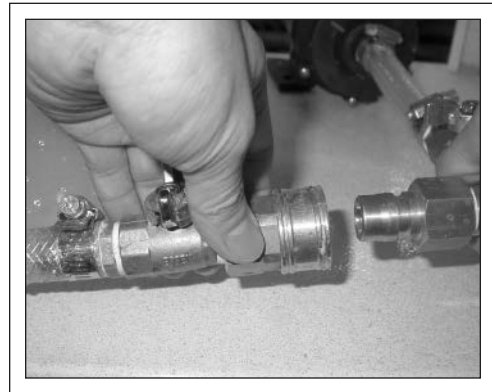
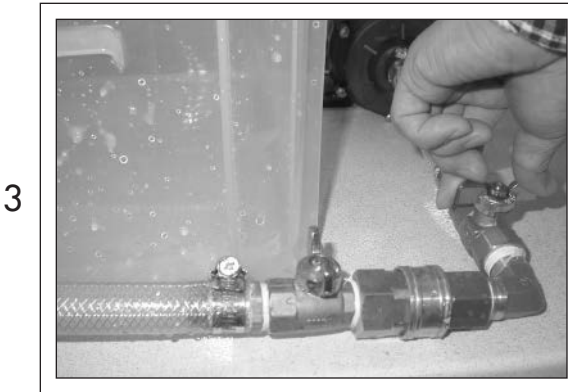
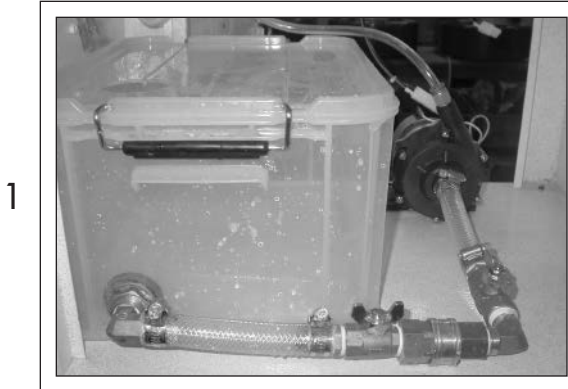

► Replacement of Timer and Micro-Switch

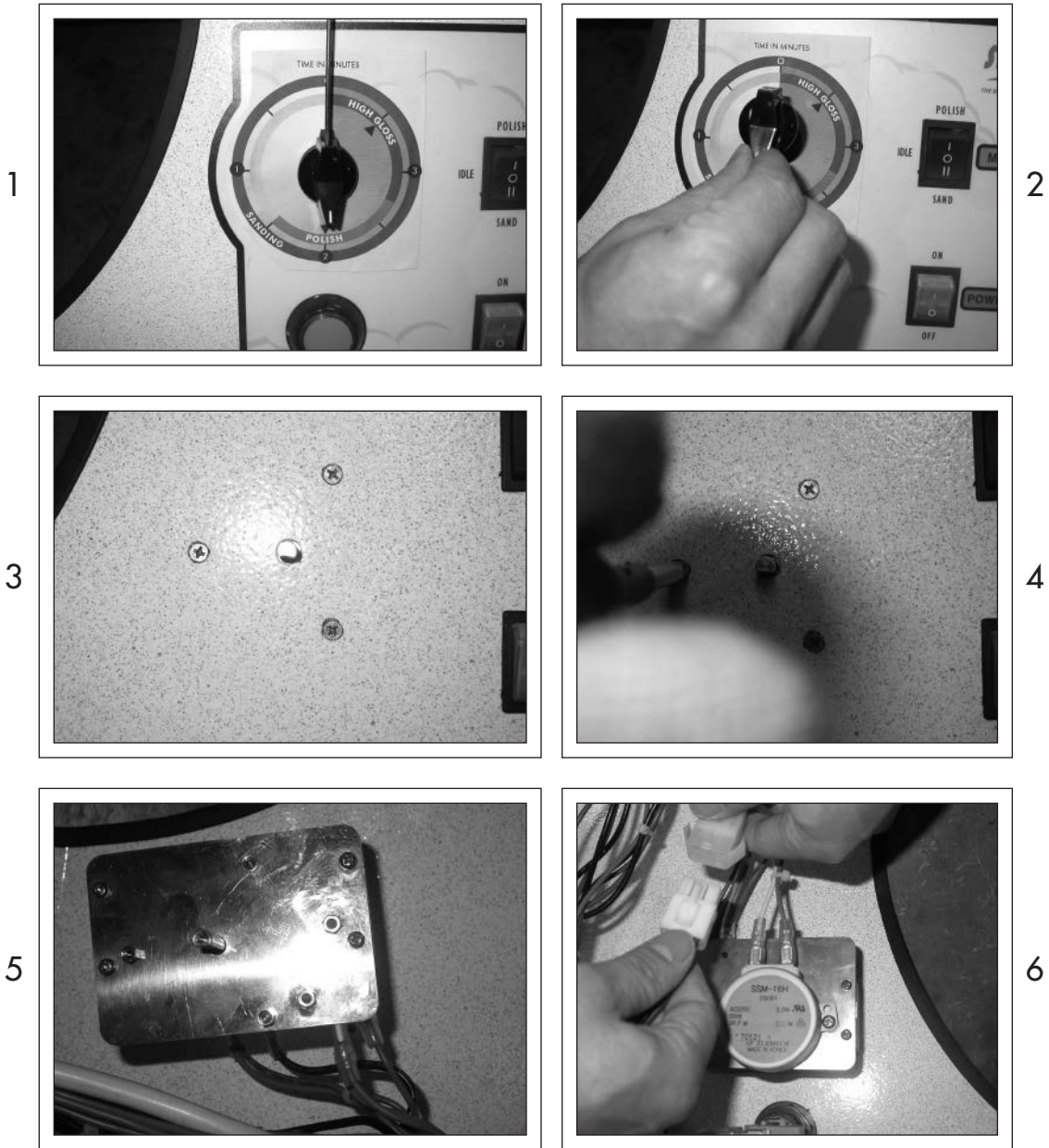

► Replacement of Power Switch and Mode Select Switch



► Opening Motor Housing

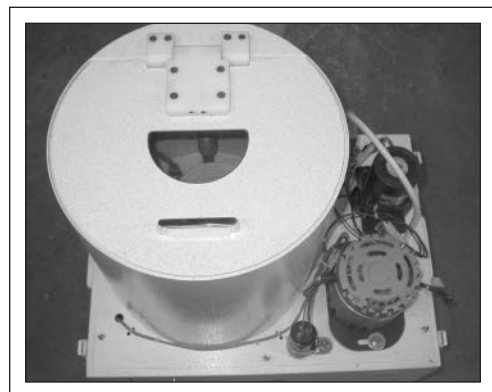
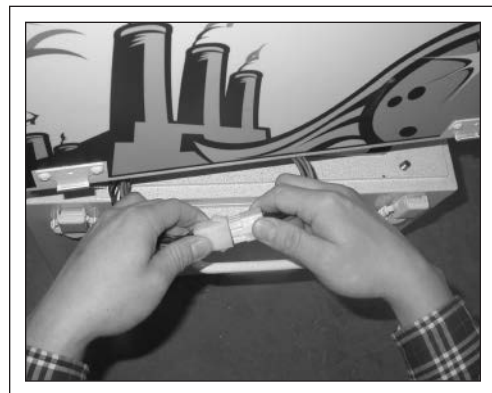
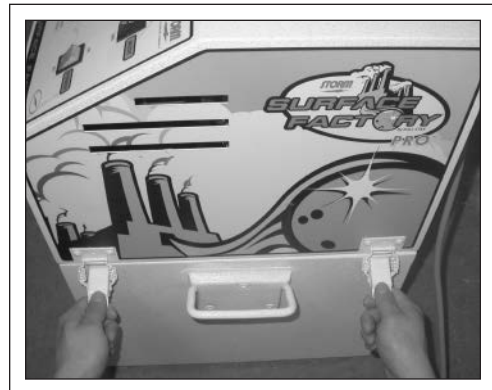

► Replacement of One-Touch Fitting

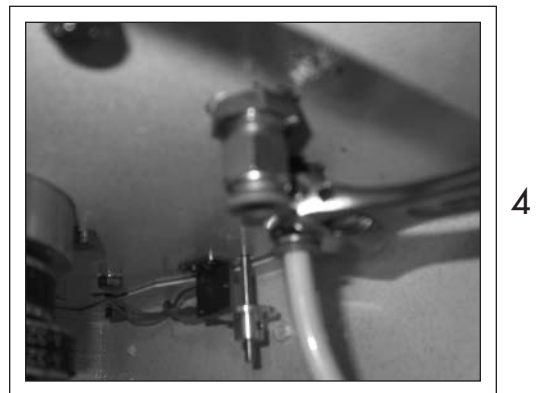
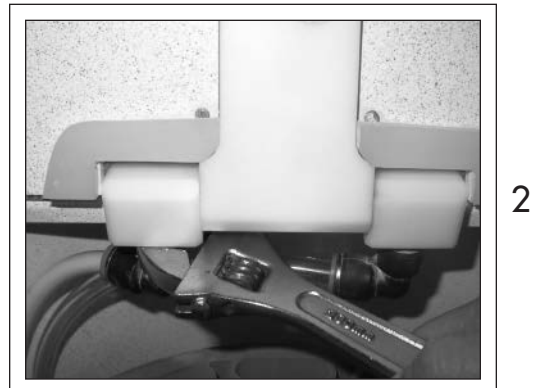
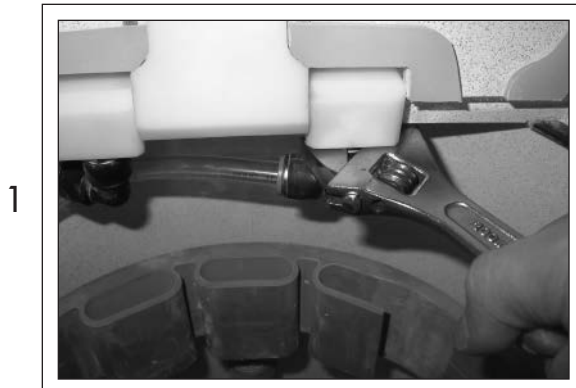

► Dismantling of Grinding Room Cover Hinge, Cleaning of Water Passage and Brightener Passage and O-Ring

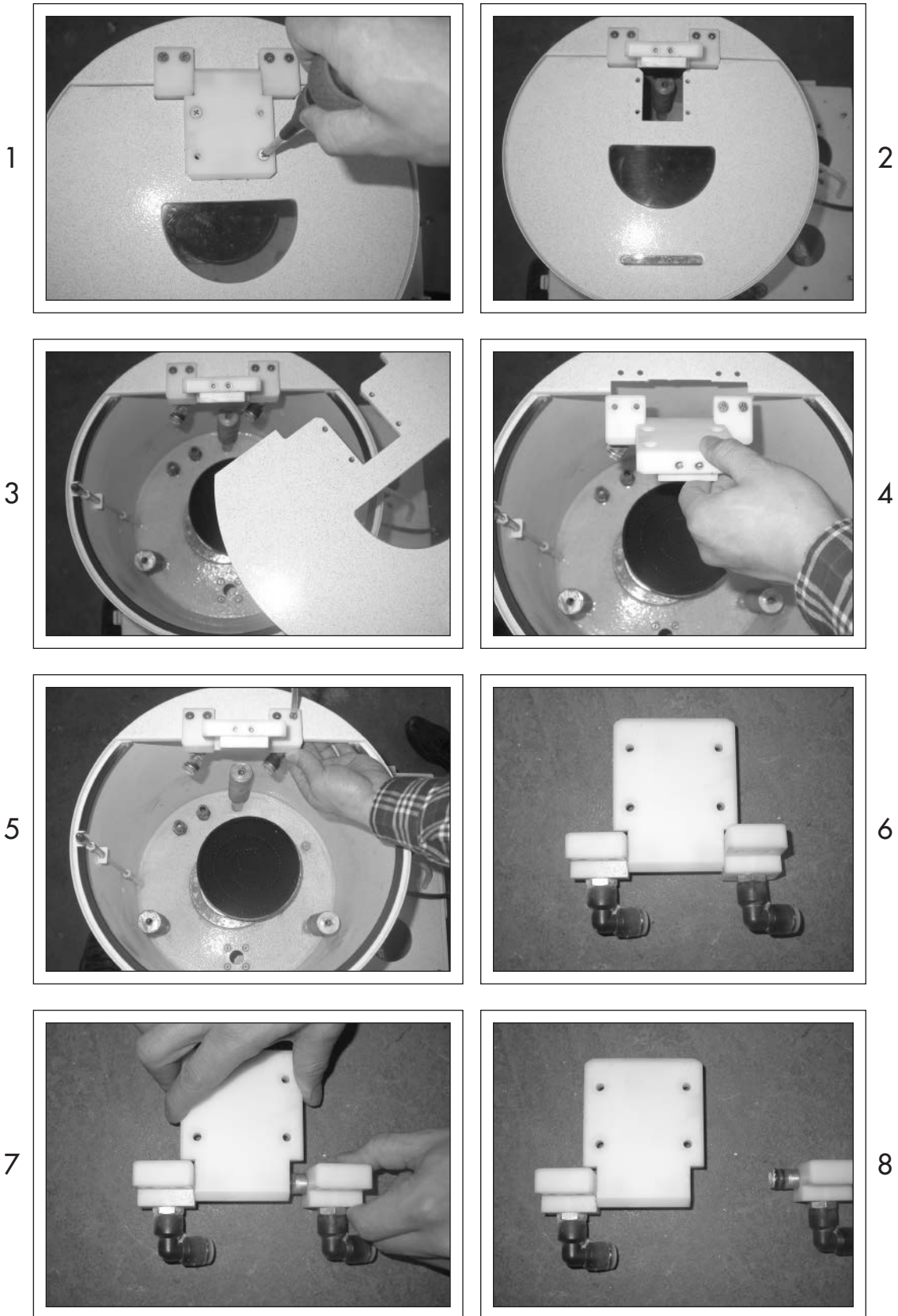

► Dismantling of Grinding Room Cover Hinge, Cleaning of Water and Brightener Passage and O-Ring *(continued)*

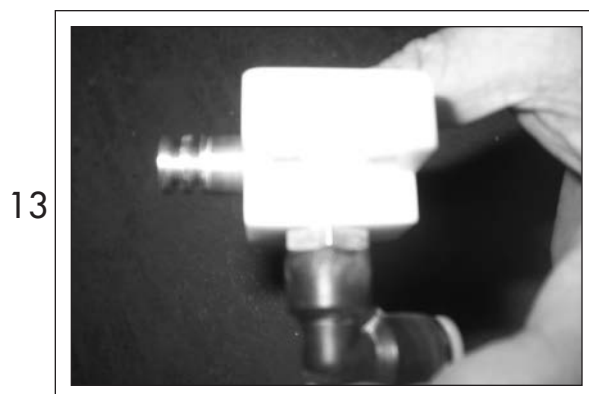
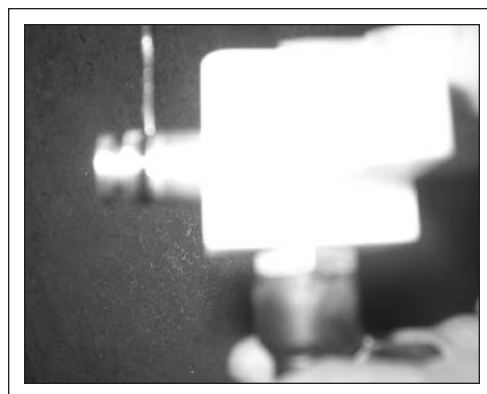
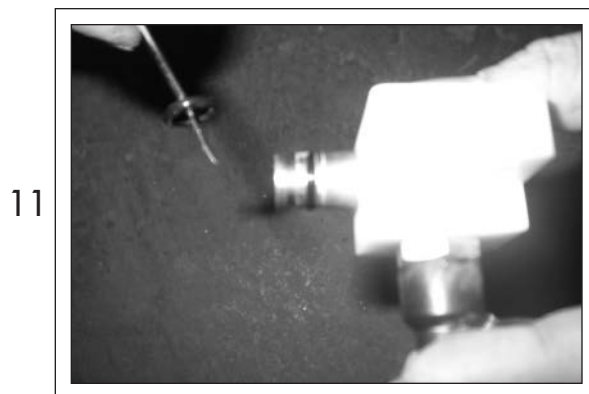
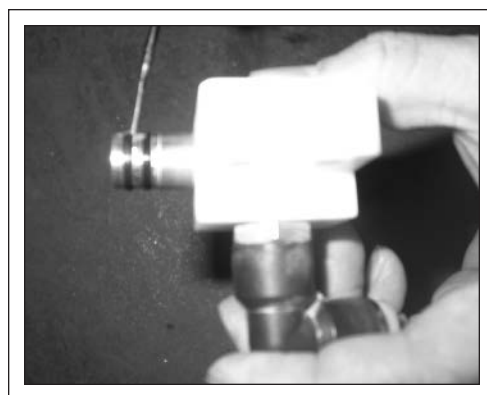

► Replacement of Fuse

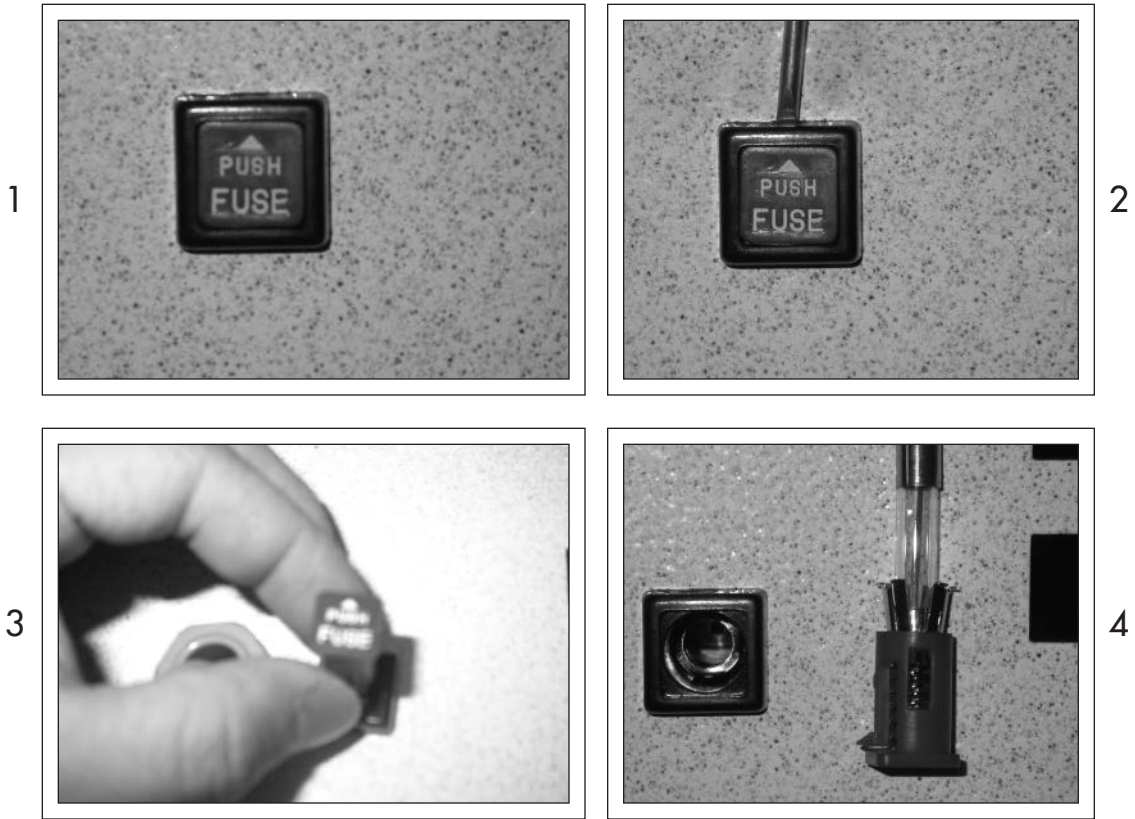

► Replacement of Cover Open Micro-Switch Set

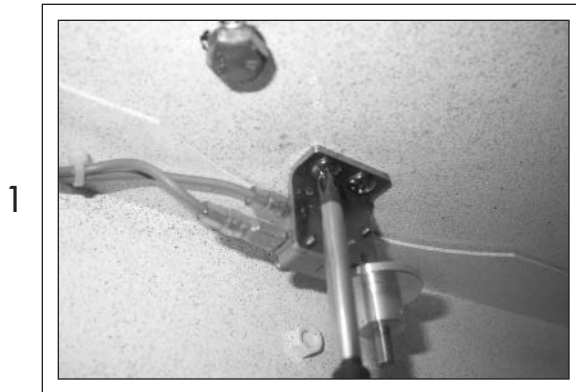

► Replacement of Wheel Set

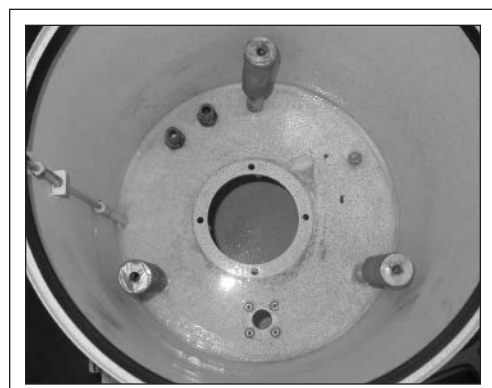
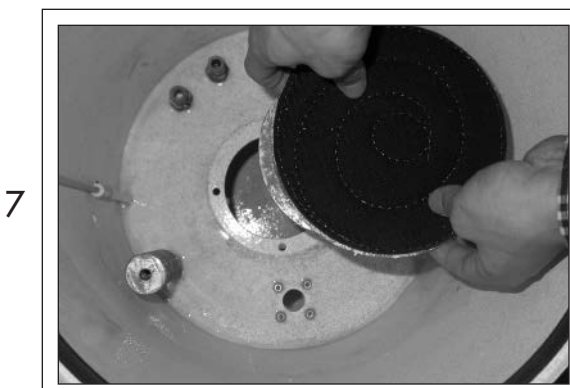
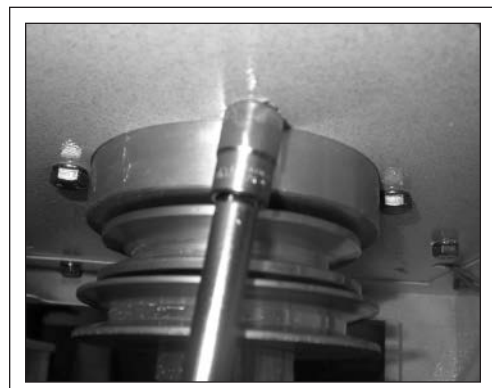
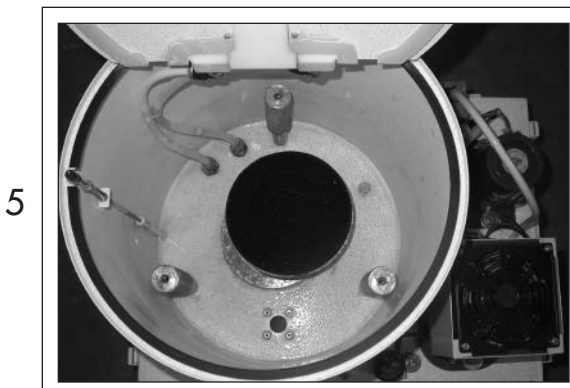
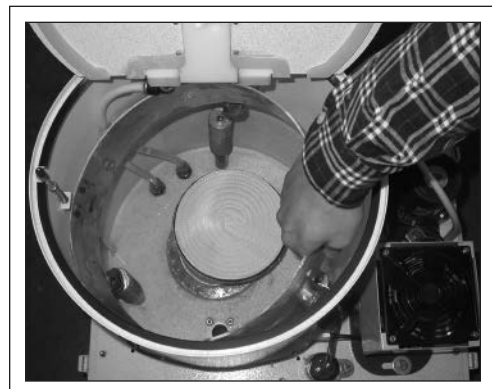
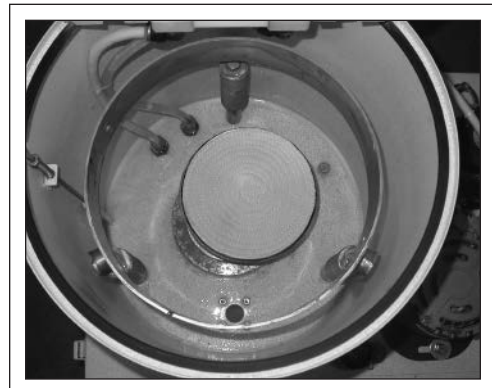

► Replacement of Water/Brightener-Supplying Transparent Urethane Hose

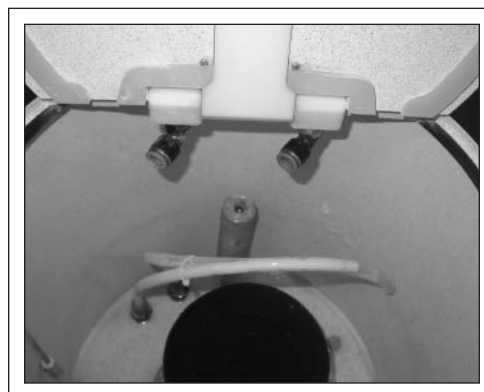

► Replacement of Relay

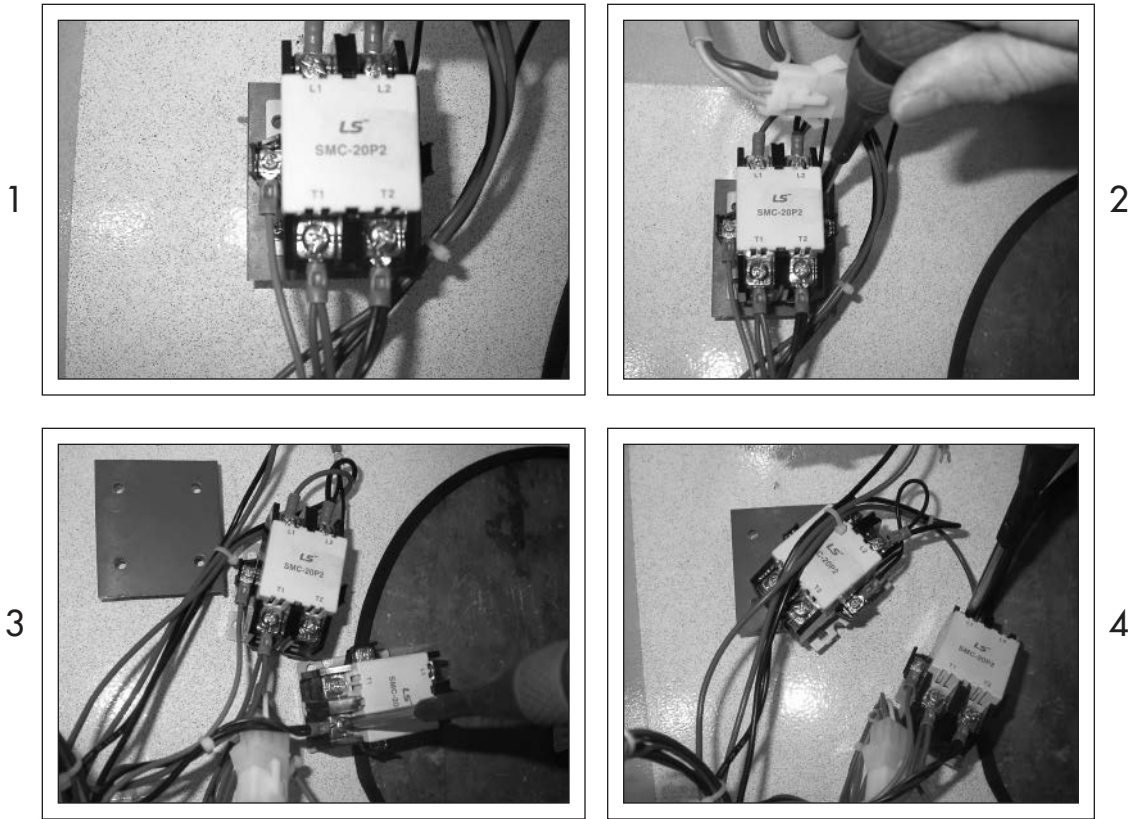

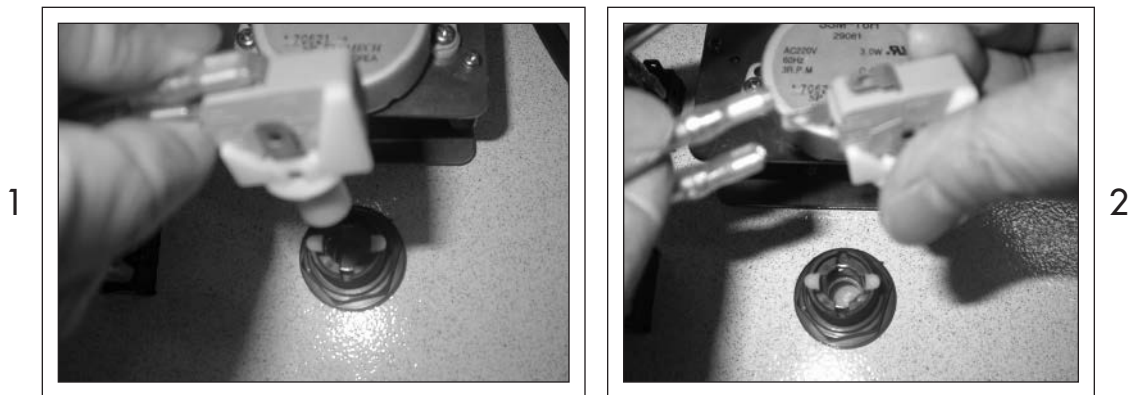

► Replacement of Polish Primer Micro-Switch



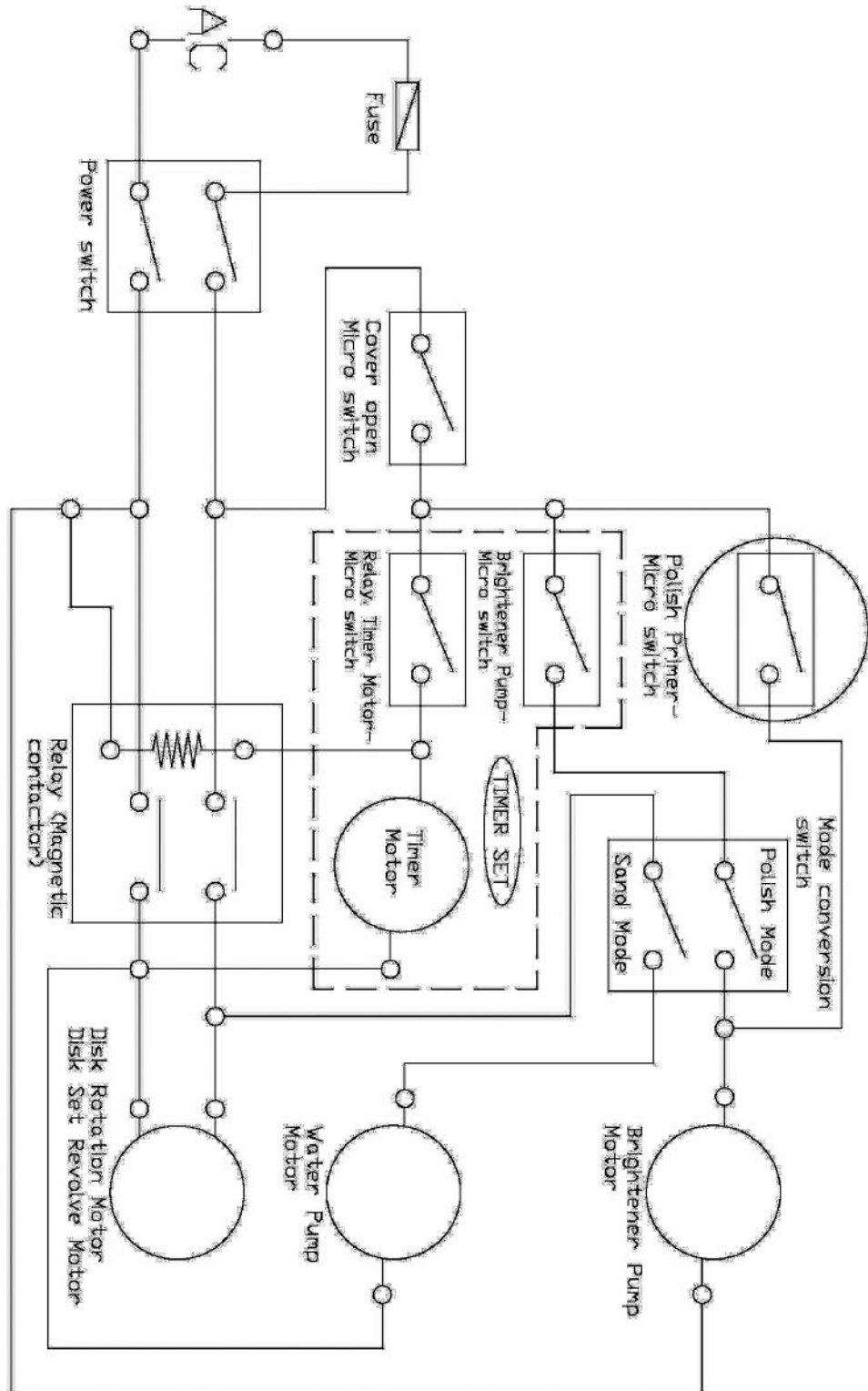





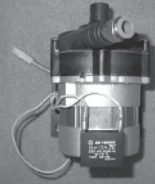

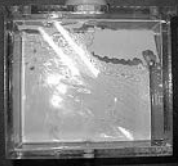

► Electronic Circuitry

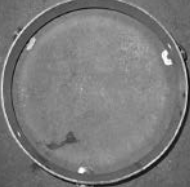

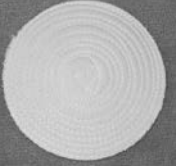

CHAPTER 5: SPARE PARTS LIST AND LOANER PARTS LIST

PART	DESCRIPTION	SIZE	WEIGHT	VOLT	SKU
	Disk Rotation Motor (Part: BSP-01)	135(W) x 200(D) x 260(H)	8Kg	AC 110V	SFP 1
	Disk SET Revolve Motor (Part: BSP-02)	95(W) x 140(D) x 180(H)	3Kg	AC 110V	SFP 2
	Brightener Pump (Part: BSP-03)	100(W) x 190(D) x 160(H)	3Kg		SFP 3
	Brightener, Water Pump Hinge Set (Part: BSP-04)	130(W) x 120(D) x 60(H)	310g		SFP 7
	Cover Open Micro-Switch SET (Part: BSP-05)	45(W) x 30(D) x 30(H)	30g		
	Wheel SET (Part: BSP-06)	200(W) x 170(D) x 270(H)	6Kg		SFP 6
	Water Pump Motor SET (Part: BSP-08)	100(W) x 162(D) x 170(H)	3Kg	AC 110V	SFP 8
	Timer SET (Part: BSP-09)	34(W) x 22(D) x 43(H)	335g	AC 110V	SFP 9

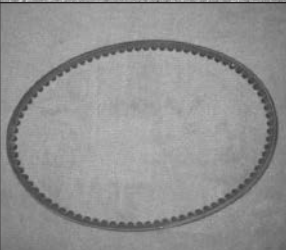
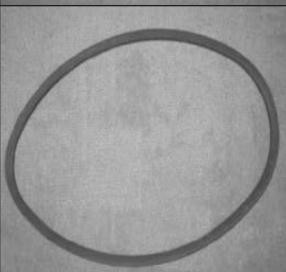
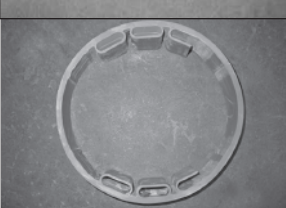
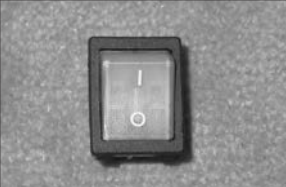
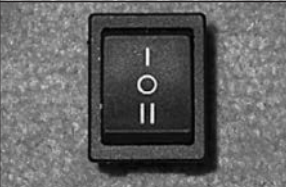
PART	DESCRIPTION	SIZE	WEIGHT	VOLT	SKU
	Water Hose Connection Coupler (Part: BSP-10)		1Kg		SFP 10
	One Touch Fitting (Part: BSP-11)				SFP 11
	One Touch Fitting (Part: BSP-12)				SFP 11
	Brightener Tank (Part: BSP-13)	160(W) x 130(D) x 220(H)			SFP 13
	Magnet Switch (Part: BSP-14)	52(W) x 72(D) x 65(H)	250g		SFP 14
	Retainer SUS Ring (Part: BSP-15)	Ø330(mm) x 50(H)	610g		SFP 15
	Retainer Installation Pole (Part: BSP-16)				SFP 16
	Water Tank (Part: BSP-17)				SFP 17
	Polishing Pad (Part: BSP-18)	Ø158(mm)	35g		SFP 18

PART	DESCRIPTION	SIZE	WEIGHT	VOLT	SKU
	Compound Pump Rubber Tube (Part: BSP-21)	35cm	100g		SFP 21
	Sanding Disk Sponge Pad (Part: BSP-22)	Ø163(mm) x 14(H)	60g		SFP 22
	Timer Knob (Part: BSP-23)	34(W) x 27(D) x 17(H)	10g		SFP 23
	Disk Rotation Motor Belt V-Belt (Part: BSP24A:50Hz BSP24B:60Hz)				SFP 24
	Disk SET Revolve Motor Belt V-Belt (Part: BSP25A:50Hz BSP25B:60Hz)				SFP 25
	Retainer Rubber Bumper (Part: BSP-26)	Ø275(mm) x 180(H)	470g		SF 32
	Power Switch (Part: BSP-27)	34(W) x 27(D) x 45(H)	15g		SFP 27
	Mode Conversion Switch (Part: BSP-28)	34(W) x 27(D) x 40(H)	15g		SFP 28

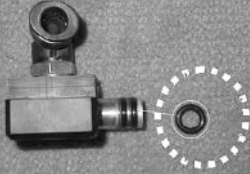
PART	DESCRIPTION	SIZE	WEIGHT	VOLT	SKU
	Polish Primer Switch (Part: BSP-29)				SFP 29
	Brightener Supply Urethane Hose (Part: BSP-30)	45cm	25g		SFP 30
	Water Supply Hose (Part: BSP-31)	58cm	30g		SFP 30
	Brightener/ Water Route Hinge O-Ring (Part: BSP-32)	Ø12	0.2g		SFP 32
	Handle Key				SFP 33